

Leadership



Even more **good** news:

**Strategies serve gamers better
than “cheat codes.”**

Here are 4 to help you master your
path as you choose your
adventure.

Strategy 1: Start with your core.



Gratuitous “core” slide



Choosing and Using Technology

A black t-shirt is displayed against a dark background. The t-shirt has a white label at the collar. The main text on the t-shirt is printed in large, bold, white, all-caps letters. The text reads: "EASILY DISTRACTED BY SHINY OBJECTS".

**EASILY
DISTRACTED
BY SHINY
OBJECTS**

Great technological choices start
with knowing **who you are** and
what you want to do.

Technology is **one tool** to help
realize your dreams...

...and never copy the “what”
without first **understanding** the
“why.”

Strategy 2: Kick-start Collaboration

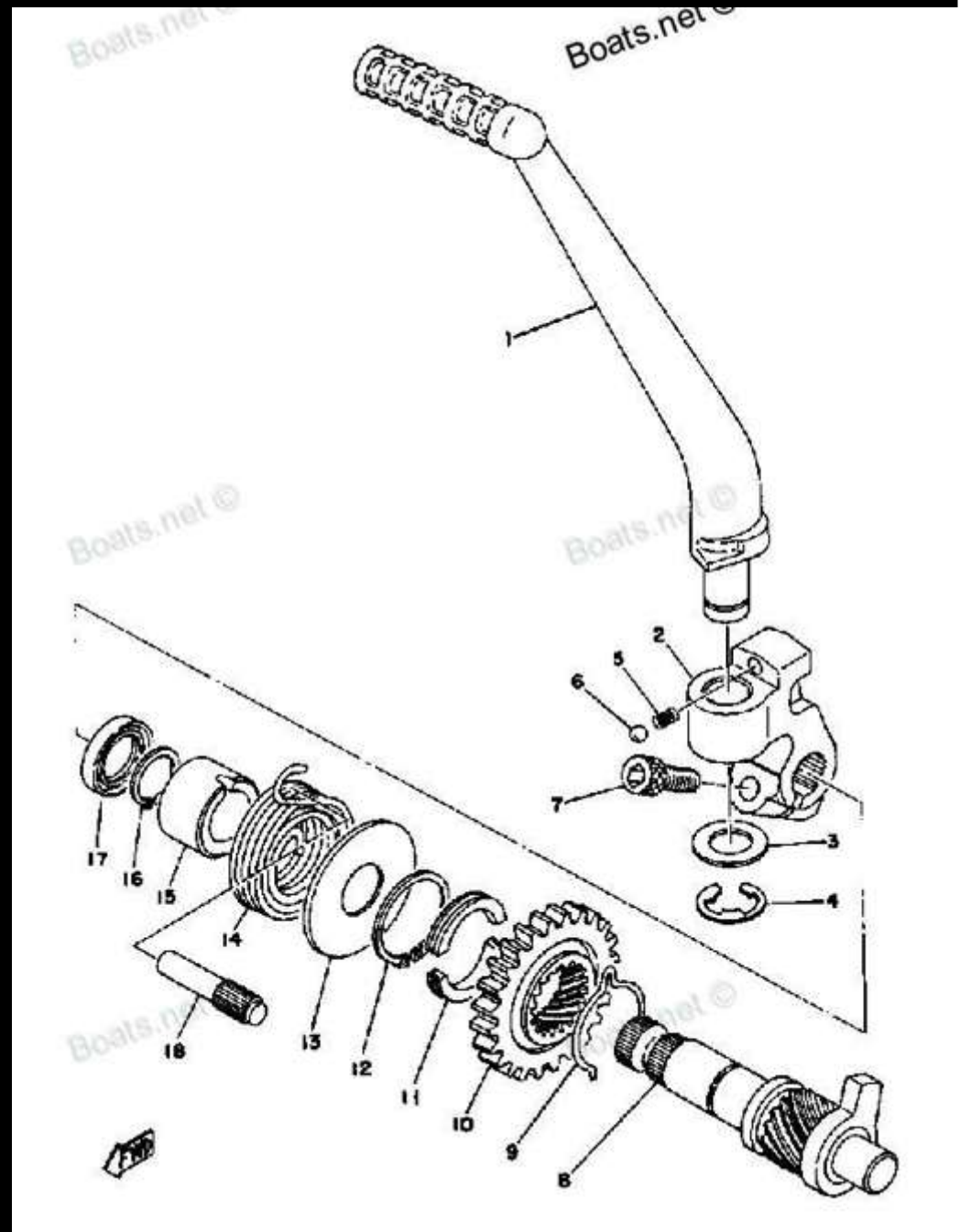

Collaborations “R” Us

@1 is the loneliest #

= #epicfail*

*#epicfail, in this case, is not
the good kind of fail.

Do you express your library's real mission in your community? *

**hint: the actual mission statement may be off somewhat.*

Who else – with complementary skills or resources – has the same goals, hopes and dreams?

Find them and **engage** them!

Strategy 3: Embrace Risk / Failure as the Path to Ultimate Success



Welcome to the world of the
“perpetual pilot project”

“Embracing Failure” does not mean
being sloppy

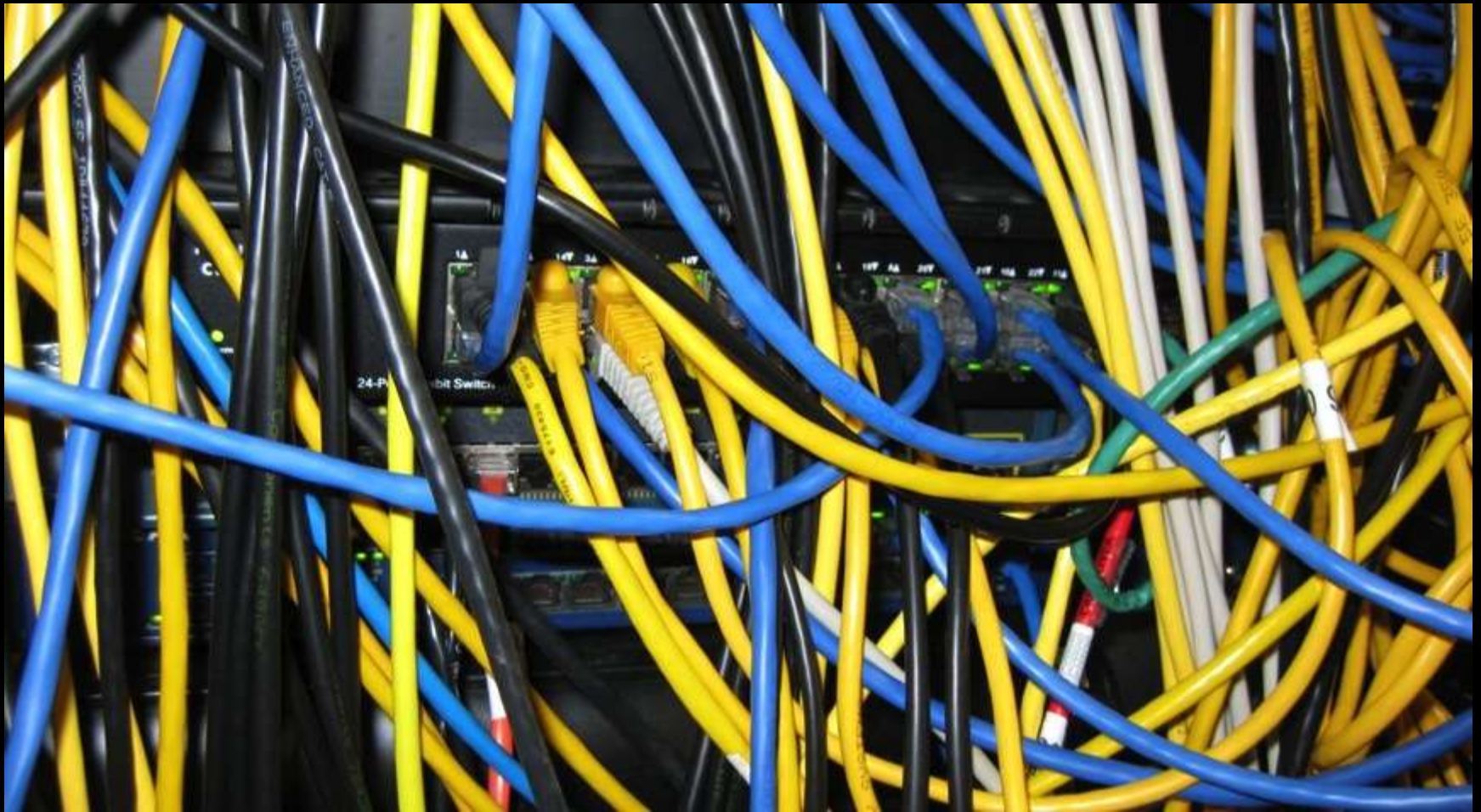

Don't make it failsafe.
Make it **safe to fail**

The example you set is
fundamentally important to those
watching you.

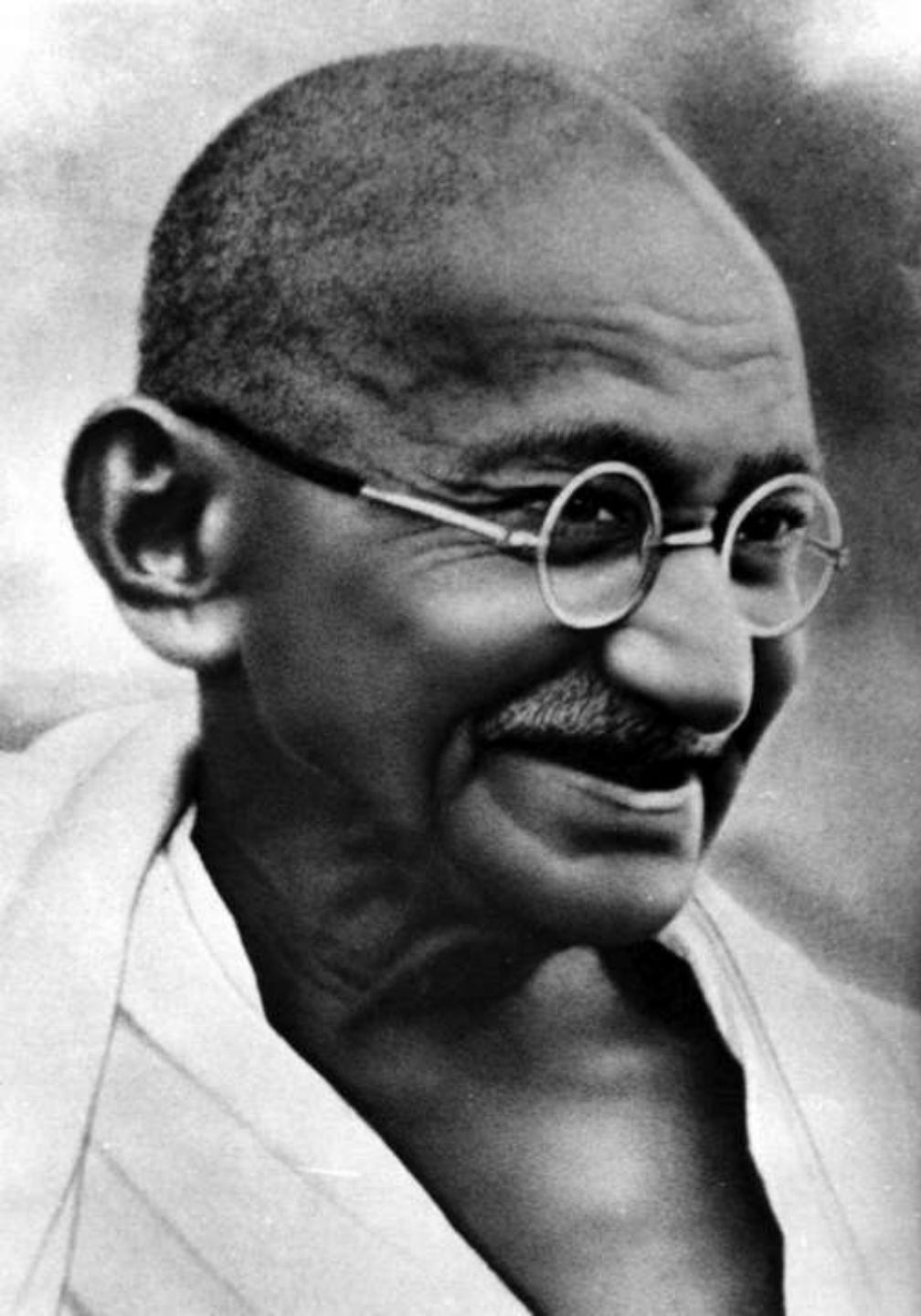

Be the
change you
wish to see
in the world.

“Be the change you wish to see in
the world” (*Mahatma Gandhi*) is
the simplest *and* toughest piece
of advice to follow since “Love your
enemies.” (*Jesus*)

Strategy 4:

Find Your
Space,
Own Your
Space, and
Make Good
Things
Happen



Think like a **servant** and you will
find **opportunities *everywhere***

- ...but also make sure “**no**” or “**stop doing**” is in
your leadership toolkit

Group work:

What risk should you take?
What strategy should you use?



The **library** is filled with **awesome**

Libraries **serve communities** in times of crisis.



New York Public Library

SEARCH: Cat Find books, r

Keyword

Home My NYPL Explore Research Using the Library Locations Classes & Events Sup

Home > Using the Library > About NYPL > Media Center > Press Releases

Getting Oriented
Library Card
How To Find Things
Research Services
Premium Services
Borrowing Materials
Computers, Internet and Wireless Access

The New York Public Library Donates Food To New Yorkers In Need After Hurricane Sandy

[Like](#) 45 [RECOMMEND](#) +1 0 [Tweet](#) 7 [EMAIL](#) [PRINT](#) [SHARE](#)

Food for 600 people will be served at several Staten Island locations on Tuesday, November 6th at 2 p.m.



Lauren Bradley

The Center for Jewish History is collecting winter coats, blankets, and warm winter clothing for Hurricane Sandy victims. If you live or work in the NYC tri-state area and want to help, please bring items to our front desk at 15 W. 16th Street.

Like · Comment · Follow Post · Tuesday at 2:10pm near New York, NY

3 people like this.

Public Library (NYPL) is donating food that would have been at a fundraising gala to feed Staten Islanders who have suffered in the wake of Hurricane Sandy.

A fundraising gala was scheduled to take place on Monday, November 5, at the A. Schwarzman Building on 42nd Street and Fifth Avenue, but the storm disrupted power to the building.

In response to the desperate need after Hurricane Sandy, the Library is donating food - which can feed about 600 people - to the recovery



Urban Librarians Unite

[Home](#)[About](#)[Calendar Of Events](#)[Contact Us](#)[Support ULU](#)[Volunteer!](#)[Where's My Library?](#)

 Urban Librarians Unite shared Queens Library's photo. Monday

Thanks Queens Library, for letting us and other staff open up the book bus on a Sunday!

Staff held story book time for children whose parents were choosing donated clothing, next to the Book Bus at Queens Library at Peninsula. A comforting story helped stressed kids and gave the adults a needed rest.

Sandy Children's Book Relief

2

Posted on **November 5, 2012** by **Bullhorn**



Libraries **serve** communities in times of crisis.

Houston Public Library – Hurricane Ike Mobile Express Technology Lab



Libraries Weather the Superstorm

By George M. Eberhart

Many served as lifelines to residents without power

Posted Sun, 11/04/2012 - 16:00

Beyond temporary power outages and minor wind and water damage, libraries along the Atlantic coast weathered Superstorm Sandy

g all the flooding and
n homes and
some areas of central
without power six days
public libraries in
owered up and serving
t centers for residents
ternet access, or heat.



The Plainsboro (N.J.) Public Library was packed with patrons seeking electrical outlets and an internet connection. Photo by New Jersey Library Association, used CC BY-NC-ND 3.0.

amage occurred on the
New York, just across
JFK International
s of Queens Library



 Queens Library shared a link via HootSuite.
Tuesday

Tens of thousands of Queens residents are suffering due to Sandy and we are here to help:
Providing internet and Wi-Fi and places to recharge cell phones;
Assisting with FEMA applications;
Bringing programs to children and families in temporary shelters;
Reaching out to all our homebound customers to find out what they need.

http://www.queenslibraryfoundation.org/site/PageServer?pagename=Help_Us_Help_Our_Neighborsv1

Help us Help Our Neighbors
www.queenslibraryfoundation.org

Tens of thousands of Queens residents are suffering due to Sandy. You can help today! We urgently need books to restore those that



Libraries **serve** **communities** in times of crisis.



<http://coloradovirtuallibrary.org/btop/content/mobile-labs-times-crisis-high-park-fire-poudre-river-public-library-district>

Libraries **serve each other** in times of crisis.



NEW YORK LIBRARY ASSOCIATION
Voice of the Library Community

[Contact Us](#) | [Login](#) | [Join](#)

- [Home](#)
- [About](#)
- [Membership](#)
- [News and Events](#)
- [Advocacy](#)
- [Career Resources](#)
- [Vendor Opportunities](#)

[Librarians](#)

[Trustees](#)

[Library Support Staff](#)

[Students](#)

[Public](#)



- 1
- 2
- 3
- 4
- 5
- 6
- 7
- 8

Help NY Libraries damaged by Hurricane Sandy

Your donations will help libraries rebuild and reopen.

[Learn how you can help. >>](#)

[Links](#)

[Headlines](#)

[Calendar](#)

[Proposed NYLA Bylaw Revisions to Be Presented at Annual](#)

[NYLA Annual Conference](#)

Librarians do their thing everywhere.

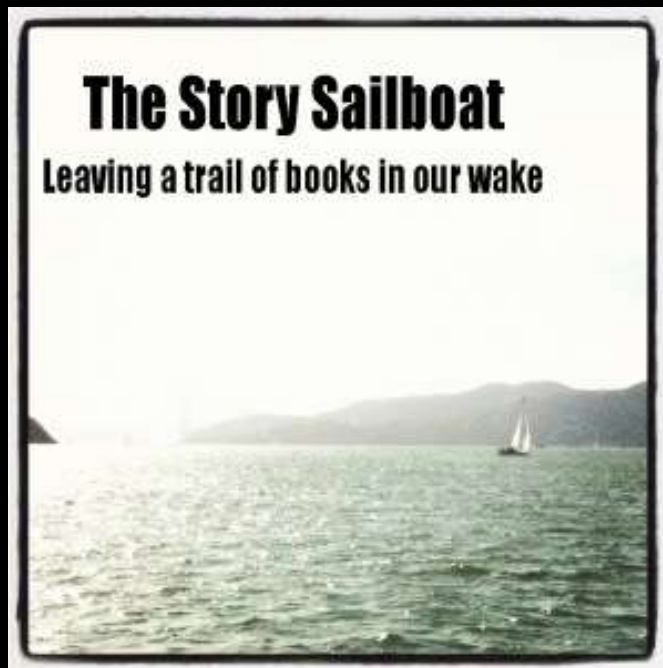

<http://thestorysailboat.com/>

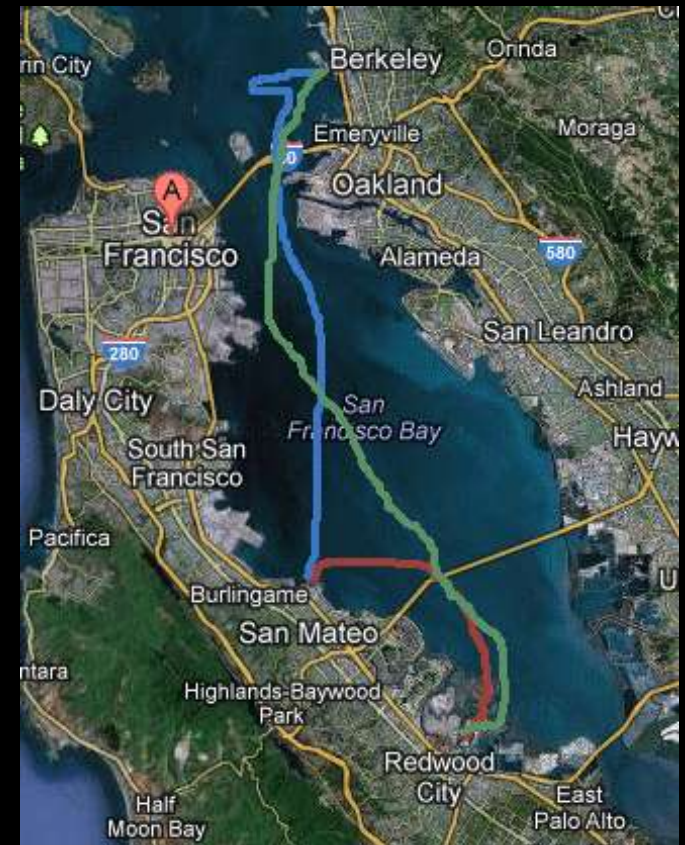

Little Free Libraries

Facebook interface showing the profile for Little Free Library.

Search for people, places and things



Little Free Library
19,704 likes · 1,312 talking about this

Like Message

ty
f community, reading for children, literacy for
d libraries around the world

Photos Likes Events Videos

19,704



Tulsa Gets Pop-Up Library at Bus Terminal

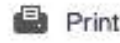
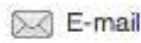

By KWGS NEWS

At Tulsa City-County Library's new pop-up library in Tulsa Transit's Denver Avenue Station, families can now see and read "The Wheels on the Bus."

Funding from the Tulsa Library Trust will establish a collection of children's books to create a pop-up library in the new play area at the Denver Avenue Station. Families waiting for their bus are encouraged to browse the collection and discover their new favorite story or find a familiar classic. Riders are asked to leave the books to enjoy during their next visit.

"Studies continually show that reading aloud to your children just 20 minutes a day will help them build essential skills for success in school and life," said Shaffer. "The more we can encourage parents and caregivers to emphasize the importance of establishing strong literacy skills, the greater ability their children will have to compete globally."



Credit Tulsa Transit

[Enlarge image](#)

The downtown station is across the street from the BOK Center

Pop-Up
Libraries

Librarybox





everylibrary

[About Us](#)

[What We Do](#)

[Our Commitment](#)

[Tools for You](#)

[The Blog](#)

Everylibrary

EveryLibrary

Building Voter Support for Libraries

Libraries need to talk to voters directly about the bonds, levys, millages, and referendum that build, renovate, or expand library services for the next generation. Any library initiative anywhere matters to every library everywhere. Make your pledge today.

[Donate Now](#)

Ben Bizzle's Dropbox of Library Promotional Images (200+ Libraries)

People will forget what you said, people will forget what you did, but people will never forget how you made them feel.

Maya Angelou

ben@benbizzle.com

HAS ONE NIGHT STAND

BUT WAY TOO MANY BOOKS TO FIT ON IT



It's called **reading**.
It's how people install new software into their brains.

“Tumblarians” (Librarians on Tumblr)

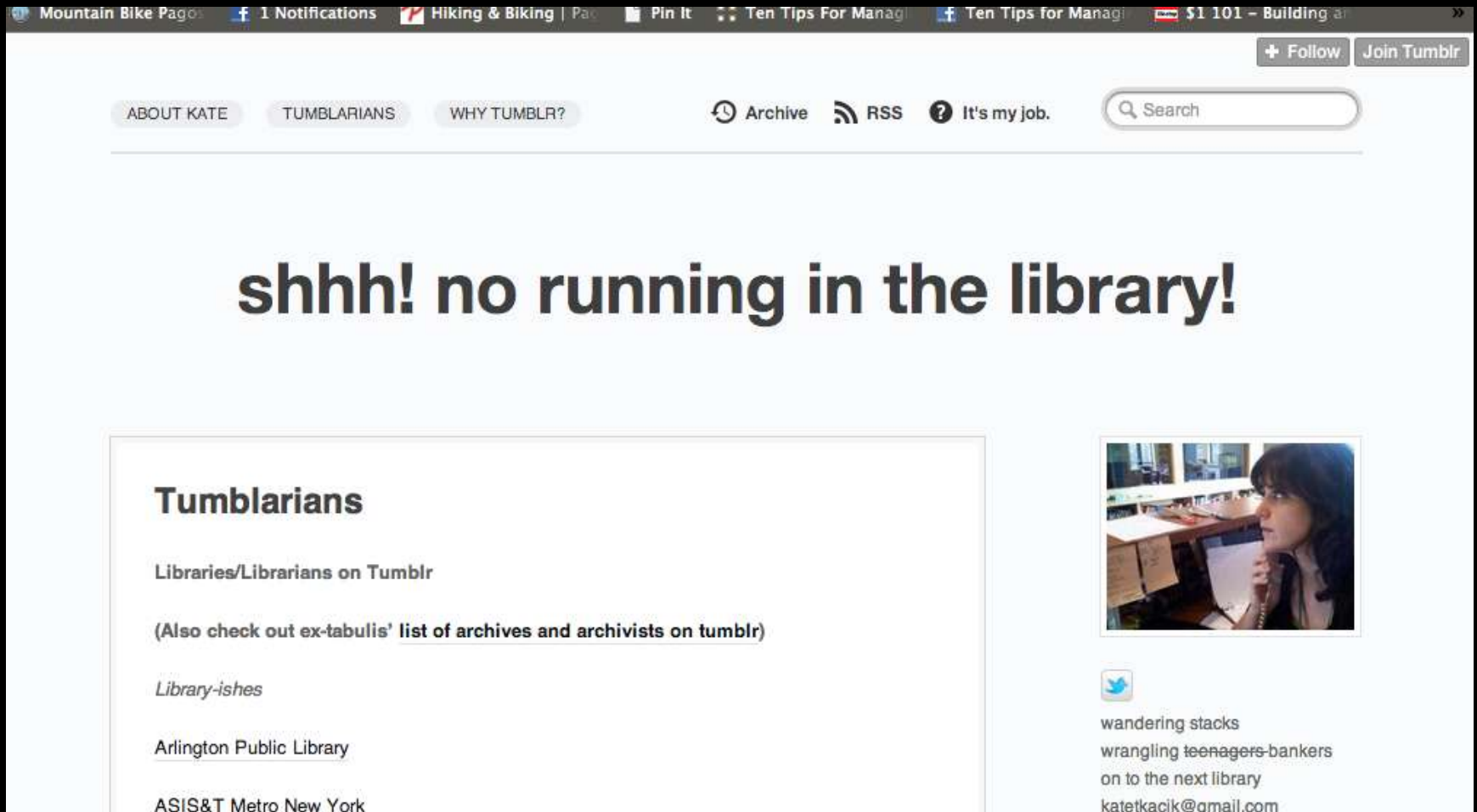

The image shows a screenshot of a Tumblr blog page. At the top, there is a browser address bar with several tabs open, including 'Mountain Bike Pagos', '1 Notifications', 'Hiking & Biking | Pak', 'Pin It', 'Ten Tips For Managi', and '\$1 101 - Building a'. Below the browser bar, there are navigation links: 'ABOUT KATE', 'TUMBLARIANS', and 'WHY TUMBLR?'. There are also icons for 'Archive', 'RSS', and 'It's my job.', along with a search bar. The main content of the page is a large, bold, black text that reads 'shhh! no running in the library!'. Below this, there is a section titled 'Tumblarians' which lists various Tumblr blogs related to libraries and librarians, including 'Libraries/Librarians on Tumblr', 'Library-ishes', 'Arlington Public Library', and 'ASIS&T Metro New York'. To the right of this list, there is a small profile picture of a woman with dark hair, and a tweet from 'wandering stacks' with the text 'wrangling teenagers-bankers on to the next library' and the email 'katetkacik@gmail.com'.

Mountain Bike Pagos 1 Notifications Hiking & Biking | Pak Pin It Ten Tips For Managi Ten Tips for Managi \$1 101 - Building a

+ Follow Join Tumblr

ABOUT KATE TUMBLARIANS WHY TUMBLR?

Archive RSS ? It's my job. Search

shhh! no running in the library!

Tumblarians

Libraries/Librarians on Tumblr

(Also check out [ex-tabulis' list of archives and archivists on tumblr](#))

[Library-ishes](#)

[Arlington Public Library](#)

[ASIS&T Metro New York](#)



 wandering stacks
wrangling teenagers-bankers
on to the next library
katetkacik@gmail.com

<http://thelifeguardlibrarian.tumblr.com/tumblarians>

“Libraries” spring up everywhere.

Klagenfurt, Austria QR Code Electronic Library
(70 titles)



<http://www.smartplanet.com/blog/cities/a-public-library-that-only-uses-qr-codes/3905>

Reading is **HOT**

Amazon thinks so.
And so does TED...



Amazon acquires Goodreads

March 2013

"Amazon and Goodreads share a passion for reinventing reading," said Russ Grandinetti, Amazon Vice President, Kindle Content. "Goodreads has helped change how we discover and discuss books and, with Kindle, Amazon has helped expand reading around the world. In addition, both Amazon and Goodreads have helped thousands of authors reach a wider audience and make a better living at their craft. Together we intend to build many new ways to delight readers and authors alike."

- Free app w/ \$2.99/title or via subscription
- Interactive content
- New publishing model: 50/50 split with authors





“...download the app...and help us reinvent the future of reading.”

- TED curator Chris Anderson

<http://blog.ted.com/2012/07/20/9-reasons-to-be-excited-by-the-new-ted-books-app/>

Shouldn't libraries own reading?
Librarian, Take it Back!

Libraries **care** about the right to
access information
confidentially...

...by **culture**, and by **statute**.

Libraries **curate local and unique content** and send it back to the
hive.

Libraries are a community
anchor.

Libraries are an economic
anchor.

Librarians care about
the success of
individuals and the
success of our
communities.

Choose your adventure: what will your library of the future be?



Thank You!



@CarsonBlock
www.carsonblock.com